

8-CH Bluetooth Wall Amplifier with Android



Background Music Host

Bluetooth and WIFI connection



Smart Touch Amplifiers

specification

PRODUCTS NAME :	Smart Touch Amplifiers
MODEL NO. :	NX S8 20W ANDT WALL AMPLIFIER
Output power :	8 x 20W
Max. power :	8 x 40W
Speaker Impedance :	4-8ohm
System :	Android 8.1
RAM :	2G
ROM :	16G
Network :	WIFI
CPU :	ARM Quad-Core Cortex-A35 1.5GHz
Display :	7inch HD touch screen
Resolution :	1024*600 IPS
Bluetooth Range :	10M
SNR :	98db
Frequency Response :	20 Hz-20 kHz (+/-2dB)
Music format :	Mp3, WMA, WAV, AAC, WAW, APE, OGG, etc.
Video format :	MPEG-1/2/3/4, RM/RMVB, WMV, MOV, MK, VOB, etc.
Power Requirements :	110-250VAC
Product size :	129*184.6*10.5mm
Weight :	0.7kg

Interface introduction

User's Manual

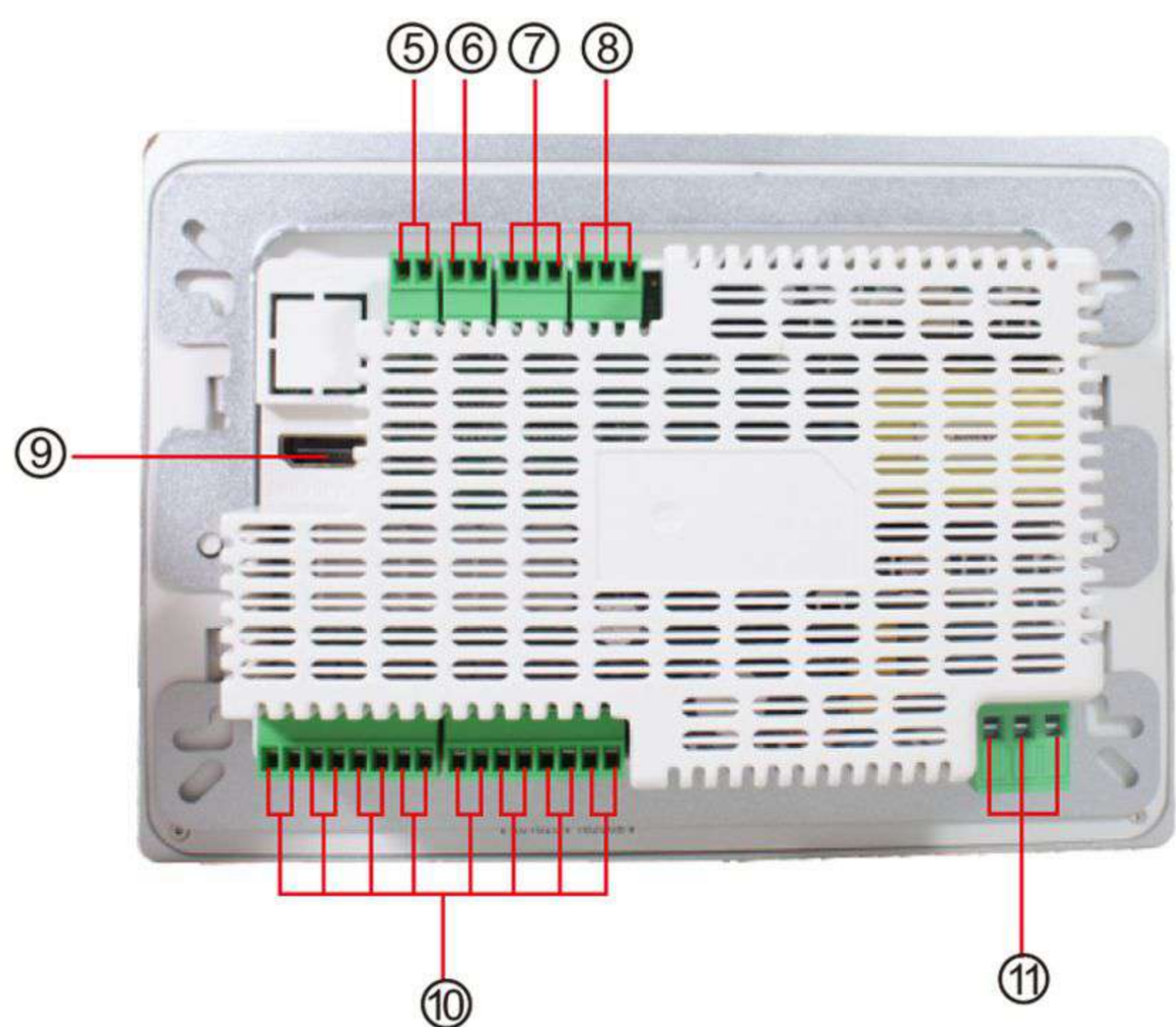

1. Power switch
2. USB port
3. TF/SD card interface
4. Power button
5. Rs485
6. Subwoofer audio output
7. AUX audio input
8. Audio output
9. HDMI output
10. Speaker output: can power 8-16 speakers
11. 110-250V AC

Remote control

User's Manual

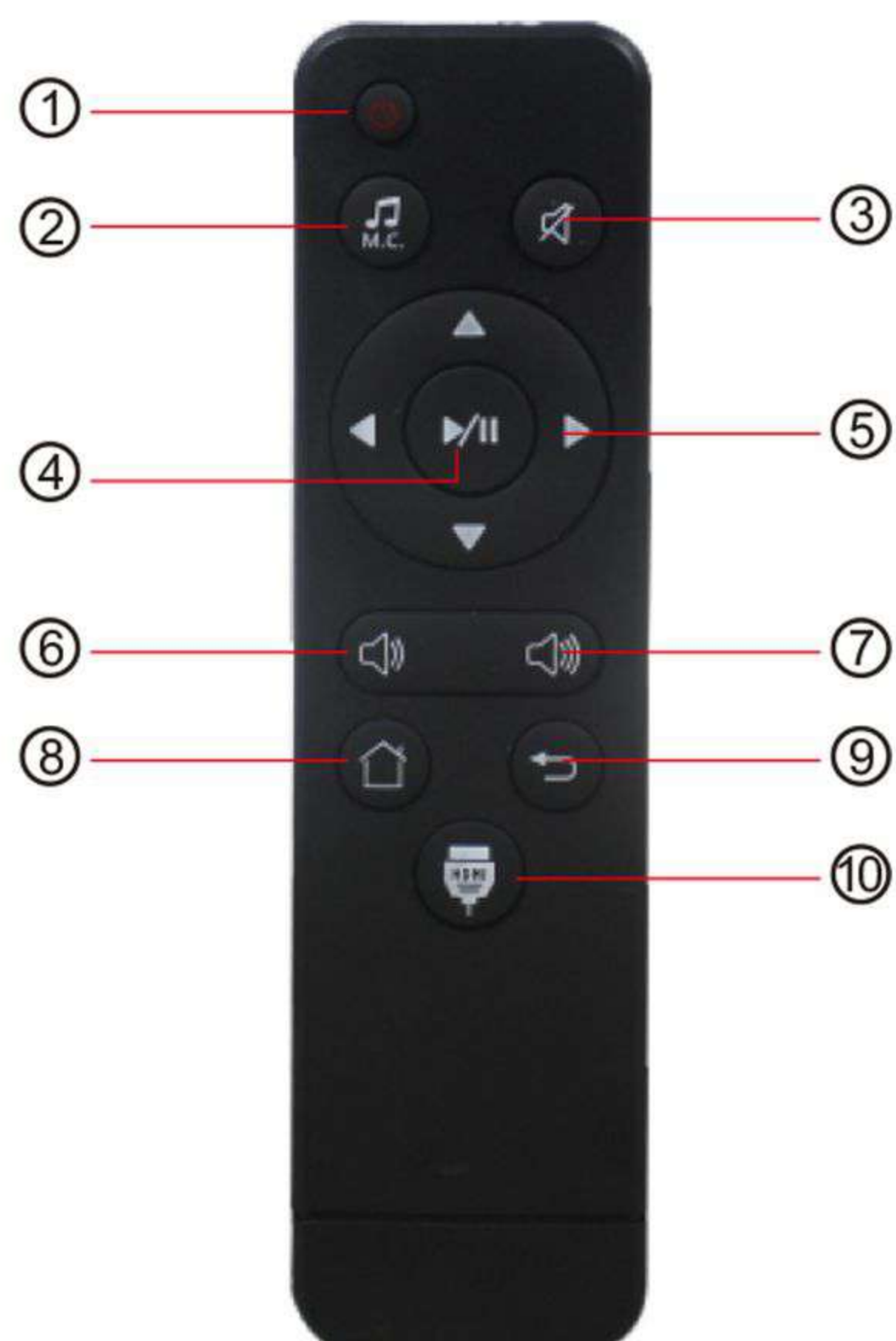

1. Power on/off: press to turn on or shut down
2. Audio source button: press this button to switch the audio source.
3. Mute
4. Pause/play/confirm
5. Arrow button: Direction, press this button to move the cursor up, down, left, and right.
6. Volume-: Press this button to decrease the volume.
7. Volume+: Press this button to increase the volume.
8. HOME: Press this button to return to the main interface.
9. Back button: Press this button in the submenu to return to the previous menu
10. HDMI

Connect with 1 piece of 8 ohm speaker in one channel
Totally 8 pieces for BA-820ADT

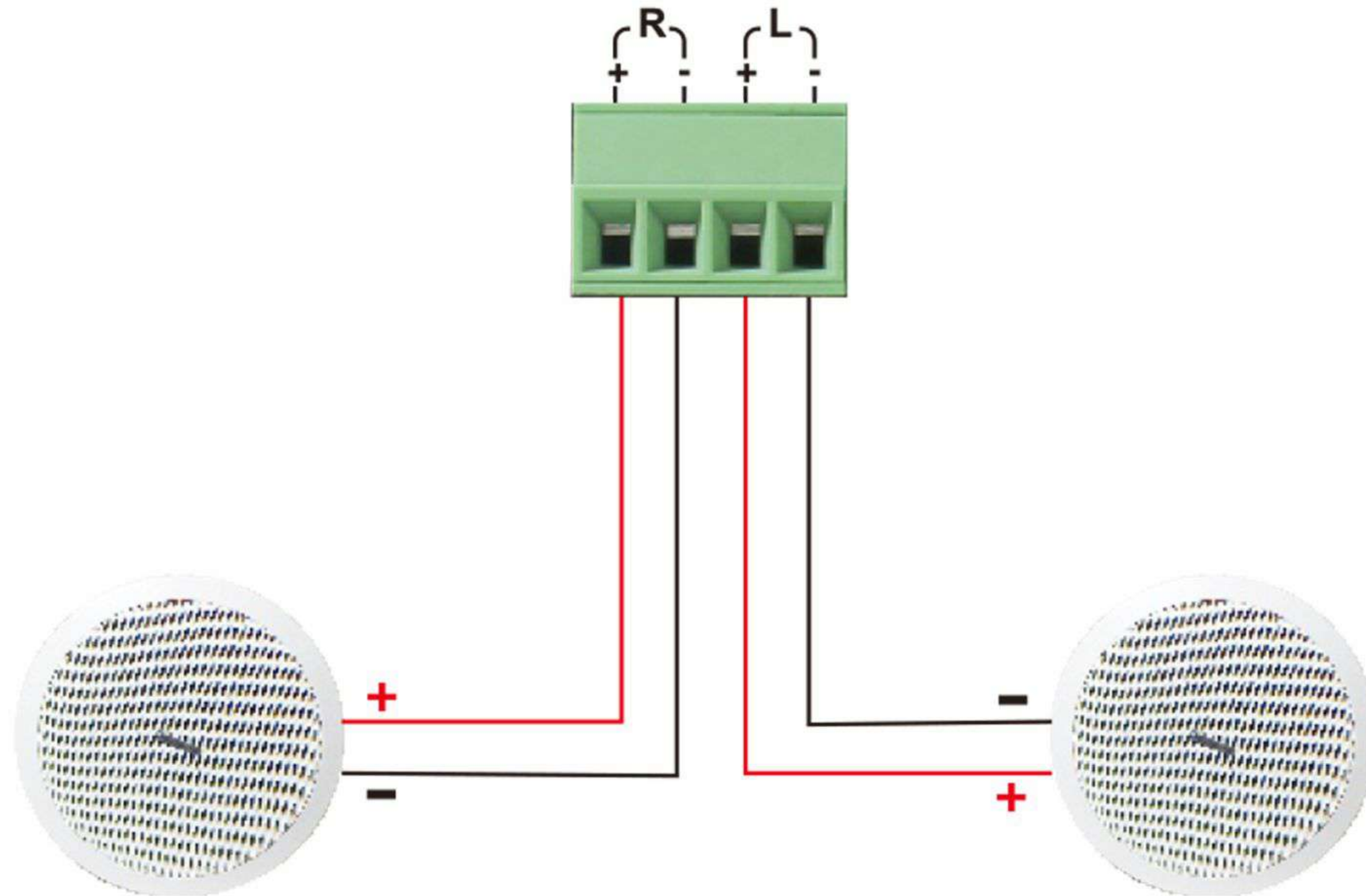

Connect with 2 piece of 8 ohm speaker in one channel
Totally 16 pieces for BA-820ADT

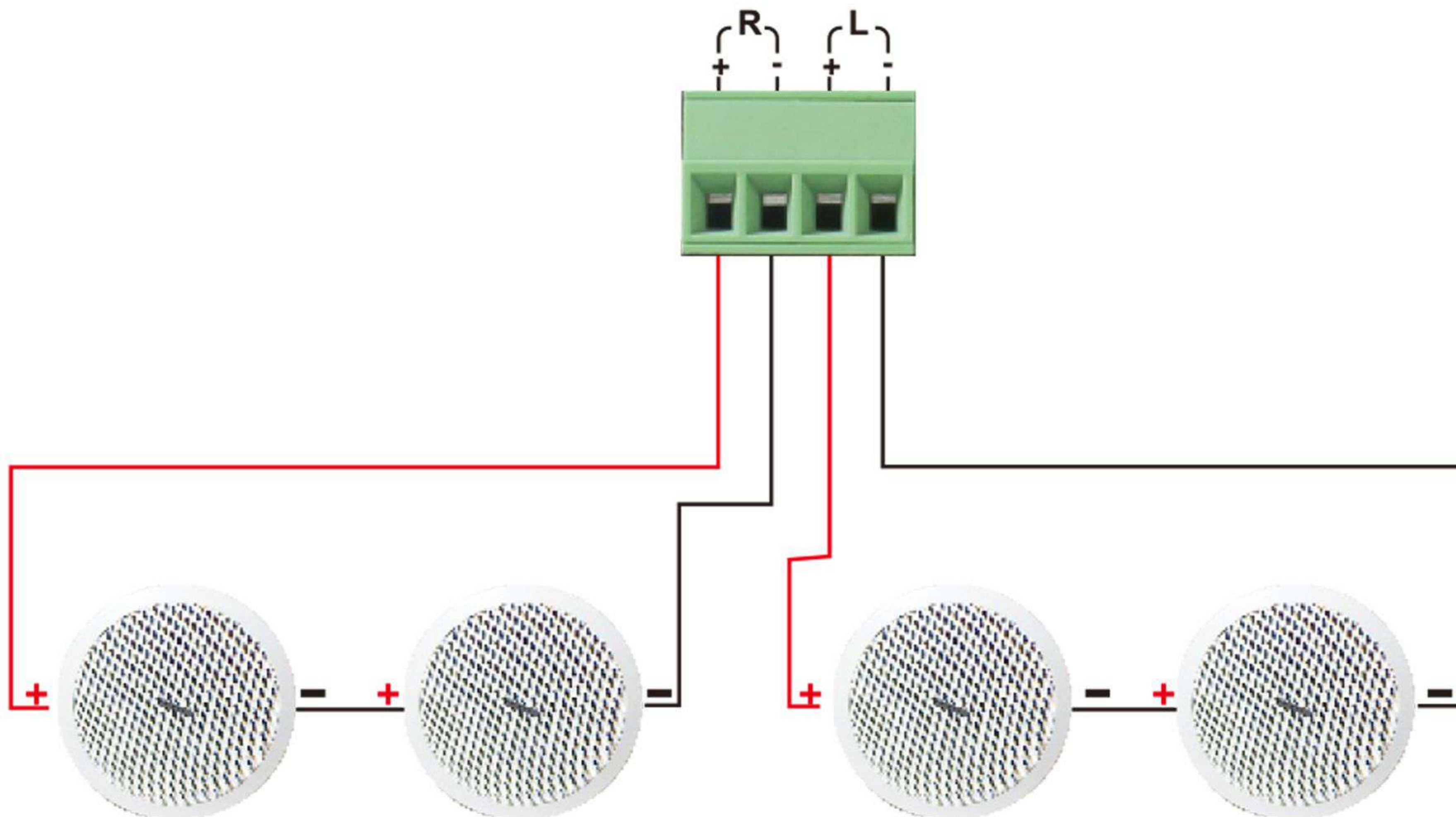

- 1.The size of the back box: 110x175x59mm
- 2.Needed cables: Multi-strand copper core cable, coaxial cable, audio cable, HDMI cable.(Suggesting use flat HDMI cable).
- 3.Please consult with the seller when you install if you have questions.
- 4.Do not repair this amplifier by yourself. Please contact the specialist to repair.

Installation steps

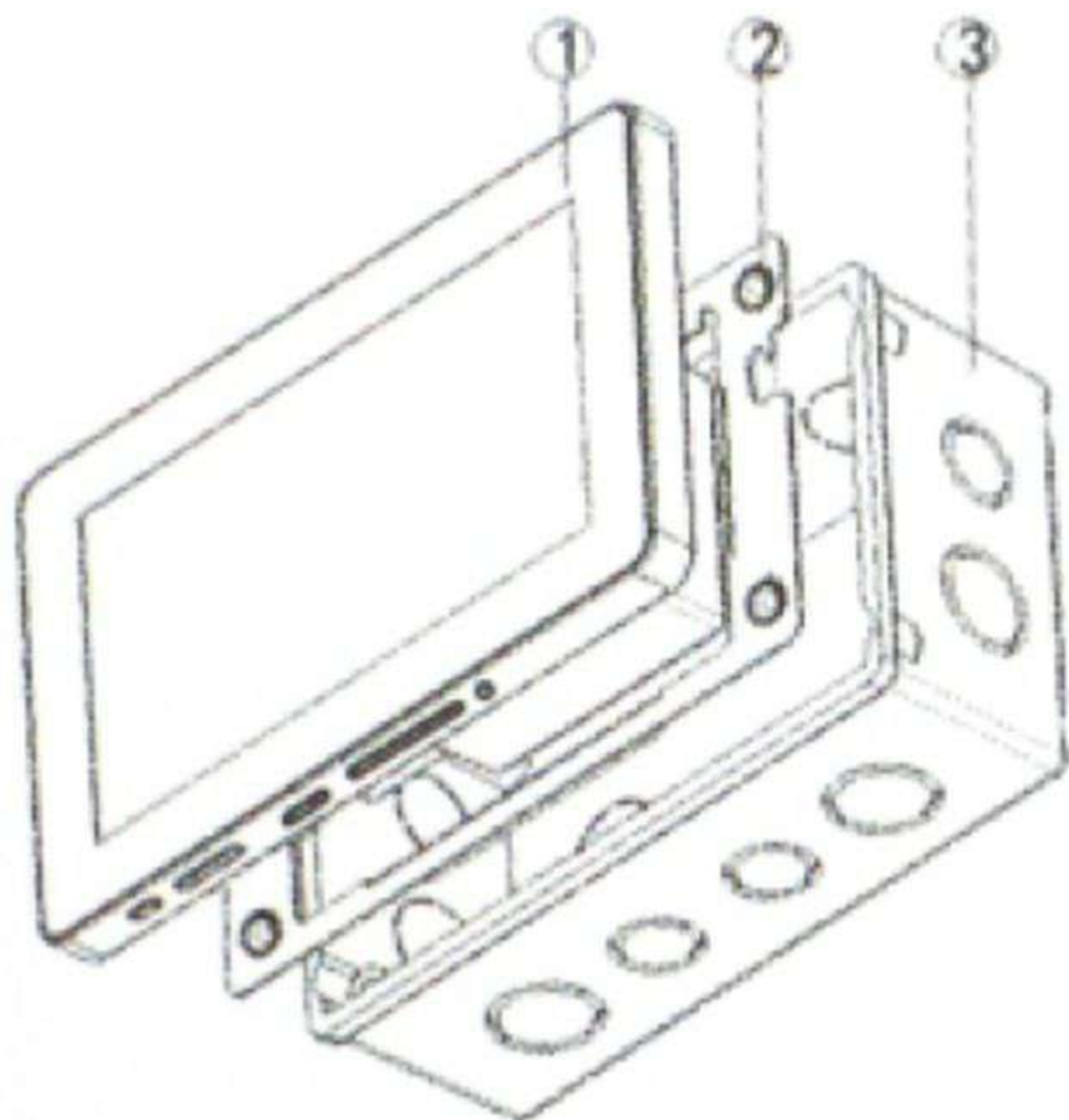

A

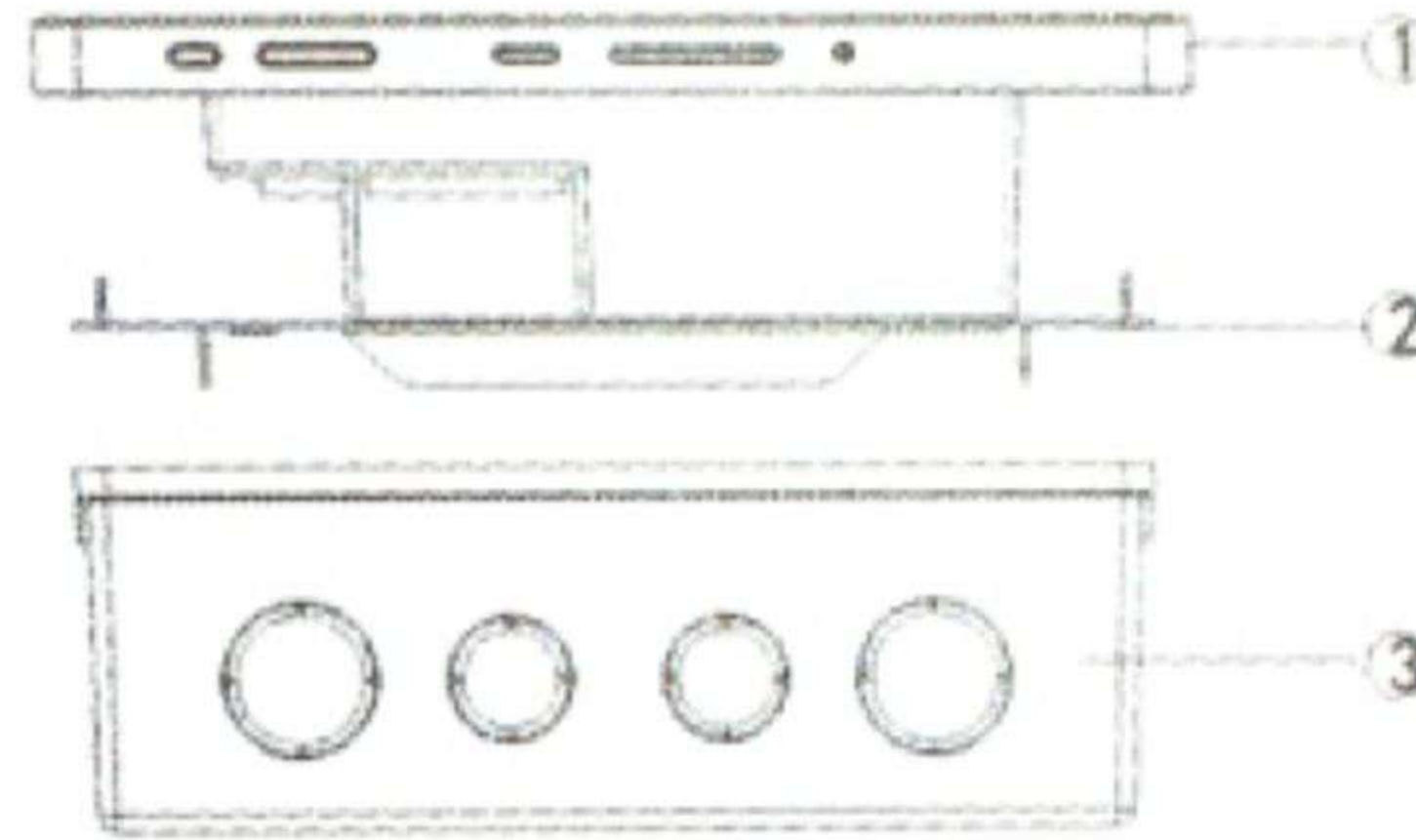

B

Side view:

1. The amplifier.
2. The metal pendant.
3. The back box.

Bottom view:

1. The amplifier.
2. The metal pendant.
3. The back box.

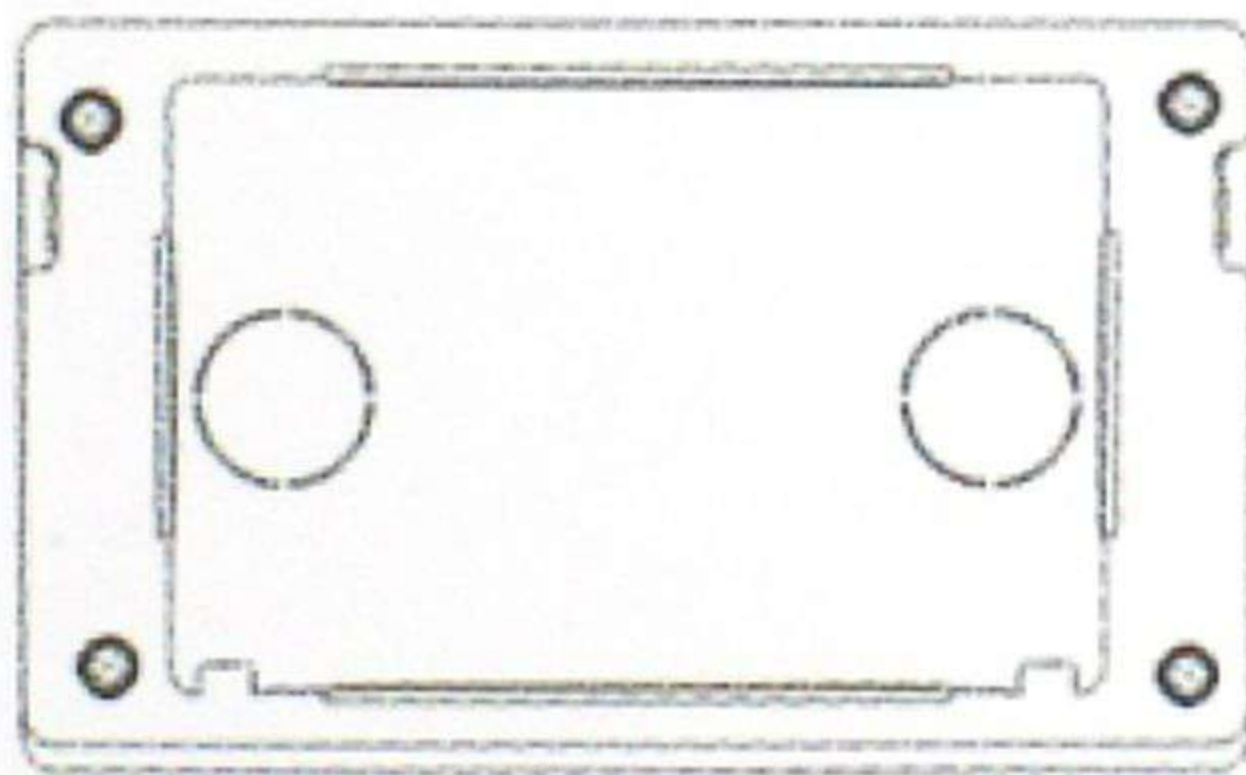

C

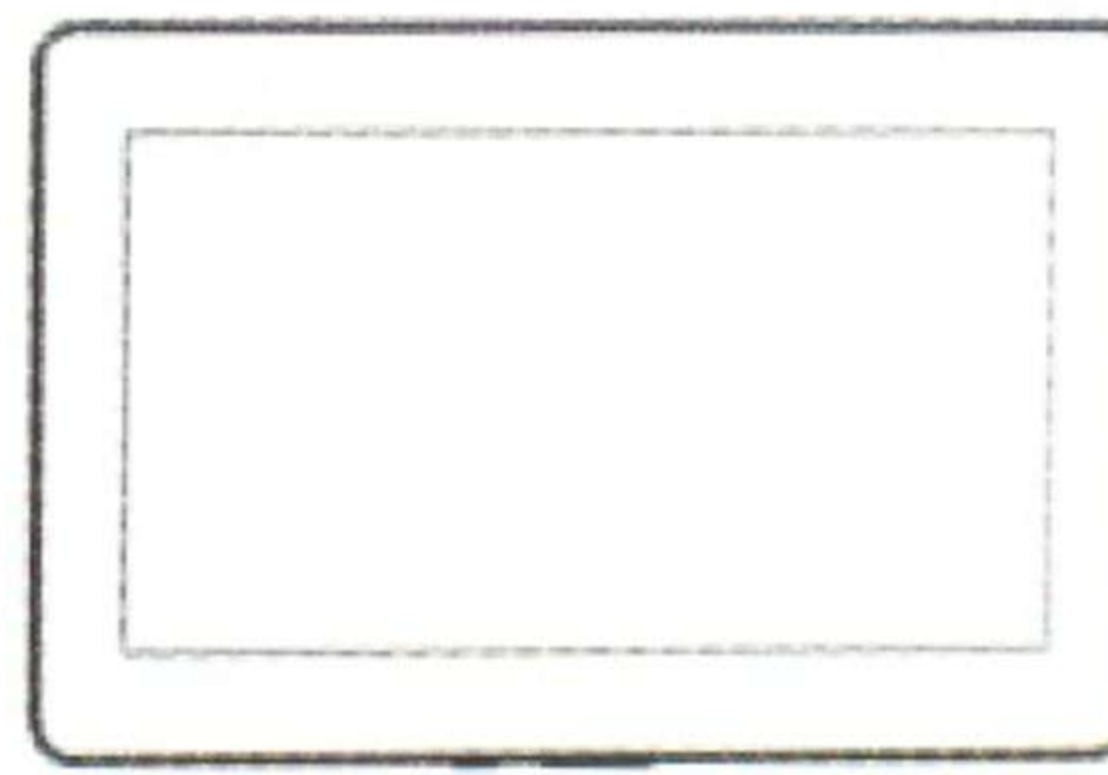

D

3.Put the back box in the wall.
Then fix the metal pendant in
the back box.

4.Put the amplifier in the
back box after wired,
Hanging it on the metal
pendant.